

**Strictly Confidential (For Internal and Restricted Use only)**  
**Senior School Certificate Examination**  
**Marking Scheme - Physics ( Code 55/1/2)**

1. The marking scheme provides general guidelines to reduce subjectivity in the marking. The answers given in the marking scheme are suggested answers. The content is thus indicated. If a student has given any other answer, which is different from the one given in the marking scheme, but conveys the meaning correctly, such answers should be given full weightage.
2. In value based questions, any other individual response with suitable justification should also be accepted even if there is no reference to the text.
3. Evaluation is to be done as per instructions provided in the marking scheme. It should not be done according to one's own interpretation or any other consideration. Marking scheme should be adhered to and religiously followed.
4. If a question has parts, please award in the right hand side for each part. Marks awarded for different part of the question should then be totaled up and written in the left hand margin and circled.
5. If a question does not have any parts, marks are to be awarded in the left hand margin only.
6. If a candidate has attempted an extra question, marks obtained in the question attempted first should be retained and the other answer should be scored out.
7. No marks are to be deducted for the cumulative effect of an error. The student should be penalized only once.
8. Deduct  $\frac{1}{2}$  mark for writing wrong units, missing units, in the final answer to numerical problems.
9. Formula can be taken as implied from the calculations even if not explicitly written.
10. In short answer type question, asking for two features/ characteristics/ properties if a candidate writes three features, characteristics/ properties or more, only the correct two should be evaluated.
11. Full marks should be awarded to a candidate if his/ her answer in a numerical problem is close to the value given in the scheme.
12. In compliance to the judgement of the Hon'ble Supreme Court of India, Board has decided to provide photocopy of the answer book(s) to the candidates who will apply for it along with the requisite fee from 2012 examination. Therefore, it is all the more important that the evaluation is done strictly as per the value points given in the marking scheme so that the Board could be in a position to defend the evaluation at any forum.
13. The Examiner shall also have to certify in the answer book that they have evaluated the answer book strictly in accordance with the value points given in the marking scheme and correct set of question paper.
14. Every Examiner shall also ensure that all the answers are evaluated, marks carried over to the title paper, correctly totaled and written in figures and words.
15. In the past it has been observed that the following are the common types of errors committed by the Examiners
  - Leaving answer or part thereof unassessed in an answer script.
  - Giving more marks for an answer than assigned to it or deviation from the marking scheme.
  - Wrong transference of marks from the inside pages of the answer book to the title page.
  - Wrong question wise totaling on the title page.
  - Wrong totaling of marks of the two columns on the title page.
  - Wrong grand total.
  - Marks in words and figures not tallying
  - Wrong transference to marks from the answer book to a ward list.
  - Answer marked as correct ( ) but marks not awarded
  - Half or part of answer marked correct ( ) and the rest as wrong ( ) but no marks awarded
16. Any unassessed portion, non carrying over of marks to the title page or totaling error detected by the candidate shall damage the prestige of all the personnel engaged in the evaluation work as also of the Board. Hence in order to uphold the prestige of all concerned, it is again reiterated that the instructions be followed meticulously and judiciously.

**MARKING SCHEME**  
**SET 55/ 1/ 2 ( DELHI)**

Q No.	Expected Answer/ Value Points	Marks	Total Marks				
1.	$V = E - Ir$	1	1				
2.	Bi and Cu	$\frac{1}{2} + \frac{1}{2}$	1				
3.	$I = \frac{P}{V} = \frac{630}{210} = 3A$	1	1				
4.	Magnitude of conduction & displacement currents are zero	1	1				
5.	( 1, 3) and ( 2, 4)	$\frac{1}{2} + \frac{1}{2}$	1				
6.	Heat waves, as they are transverse/electromagnetic in nature	1	1				
7.	$A + \delta_m = 2i$	1	1				
8.	Spherical .	1	1				
9.	<table border="1" style="width: 100%; border-collapse: collapse;"> <tr> <td style="width: 60%;">Identification of X and Y</td> <td style="width: 40%; text-align: right;"><math>\frac{1}{2} + \frac{1}{2}</math></td> </tr> <tr> <td>Function of X and Y</td> <td style="text-align: right;"><math>\frac{1}{2} + \frac{1}{2}</math></td> </tr> </table> <p>X: IF stage Y: Amplifier</p> <p>The carrier frequency is changed to a lower frequency by intermediate frequency (IF) stage preceding the detection It increases the strength of detected signal</p>	Identification of X and Y	$\frac{1}{2} + \frac{1}{2}$	Function of X and Y	$\frac{1}{2} + \frac{1}{2}$	$\frac{1}{2}$ $\frac{1}{2}$ $\frac{1}{2}$ $\frac{1}{2}$	2
Identification of X and Y	$\frac{1}{2} + \frac{1}{2}$						
Function of X and Y	$\frac{1}{2} + \frac{1}{2}$						
10.	<table border="1" style="width: 100%; border-collapse: collapse;"> <tr> <td style="width: 60%;">(i) Value of Shunt Resistance</td> <td style="width: 40%; text-align: right;">1</td> </tr> <tr> <td>(ii) Combined resistance</td> <td style="text-align: right;">1</td> </tr> </table> <p>(i) Shunt <math>S = \frac{R_A i_g}{i - i_g}</math> <math>= \frac{1 \times 1}{5 - 1} = 0.25 \Omega</math></p> <p>(ii) Total Resistance <math>\frac{1}{R_{Total}} = \frac{1}{0.25} + \frac{1}{1} = 5</math></p> <p><math>R_{Total} = \frac{1}{5} \Omega = 0.2 \Omega</math></p>	(i) Value of Shunt Resistance	1	(ii) Combined resistance	1	$\frac{1}{2}$ $\frac{1}{2}$ $\frac{1}{2}$ $\frac{1}{2}$	2
(i) Value of Shunt Resistance	1						
(ii) Combined resistance	1						

11.	<div style="border: 1px solid black; padding: 5px; margin-bottom: 10px;"> Conditions <span style="float: right;">½+½</span>  Relation <span style="float: right;">1</span> </div> <p>(a) i) Ray of light should travel from denser to rarer medium  ii) Angle of incidence should be more than the critical angle.</p> <p>(b) <math>\mu = \frac{1}{\sin i_c}</math>  where <math>i_c</math> is the critical angle</p>	½ ½  1	2
12.	<div style="border: 1px solid black; padding: 5px; margin-bottom: 10px;"> Statement of lenz law <span style="float: right;">1</span>  Enf and justification <span style="float: right;">½ +½</span> </div> <p>The polarity of induced enf is such that it tends to produce a current which opposes the change in magnetic flux that produced it.  Yes, as the magnetic flux due to vertical component of Earth's magnetic keeps on changing as the metallic rod falls down.</p>	1 ½ +½	2
13.	<div style="border: 1px solid black; padding: 5px; margin-bottom: 10px;"> (i) Effect on Brightness of the bulb and reason <span style="float: right;">½ + ½</span>  (ii) Effect on volt meter reading and reason <span style="float: right;">½ + ½</span> </div> <p>(i) Decreases  When resistance <math>R</math> is increased, base current <math>i_b</math> will decrease hence collector current will decrease. Brightness of the bulb will decrease.</p> <p>(ii) Decreases  As volt meter is connected across the bulb, therefore its reading will also decrease.</p>	½ ½ ½ ½	2
14.	<div style="border: 1px solid black; padding: 5px; margin-bottom: 10px;"> Determination of power <span style="float: right;">1 ½</span>  Nature <span style="float: right;">½</span> </div> <p>Power of convex lens</p> <p>Power of concave lens</p> <p><math>P_2 = \text{---} \quad D</math></p> <p>Power of the combination <math>P = P_1 + P_2 = +1 D</math>  Nature : Converging</p>	½   ½ ½	2

15.	<div data-bbox="228 235 1226 331" style="border: 1px solid black; padding: 5px;"> <p>Circuit diagram and working <span style="float: right;">1 ½</span>  Its use to detect the optical signal <span style="float: right;">½</span></p> </div> <p>Circuit diagram of an illuminated photodiode:</p> <div data-bbox="233 447 818 865" style="text-align: center;"> </div> <p>When the photodiode is illuminated with radiations (photons) with energy (<math>h\nu</math>) greater than the energy gap (<math>E_g</math>) of the semiconductor, then electron-hole pairs are generated due to the absorption of photons. The junction field sends the electrons to n-side and holes to p-side to produce the e.m.f. Hence current flows through the load when connected.</p> <p>It is easier to observe the change in the current with change in the radiation intensity, if a reverse bias is applied. Thus photodiode can be used as a photodetector to detect optical signals.</p> <p style="text-align: center;"><b>OR</b></p> <div data-bbox="228 1331 1193 1415" style="border: 1px solid black; padding: 5px;"> <p>Important considerations <span style="float: right;">1</span>  Order of band gap <span style="float: right;">1</span></p> </div> <ol style="list-style-type: none"> <li>1. It is a heavily doped p-n junction</li> <li>2. The reverse breakdown voltages of LEDs are very low</li> <li>3. The semiconductor used for fabrication of visible LEDs must at least have a band gap of 1.8 eV</li> </ol> <p>(Any two of the above)</p> <p>Order of band gap is about 3 eV to 1.8 eV</p>	½	1
16.	<div data-bbox="228 1717 1177 1850" style="border: 1px solid black; padding: 5px;"> <p>(a) Sketch of propagation <span style="float: right;">1 ½</span>  (b) Relation <span style="float: right;">½</span></p> </div>		2

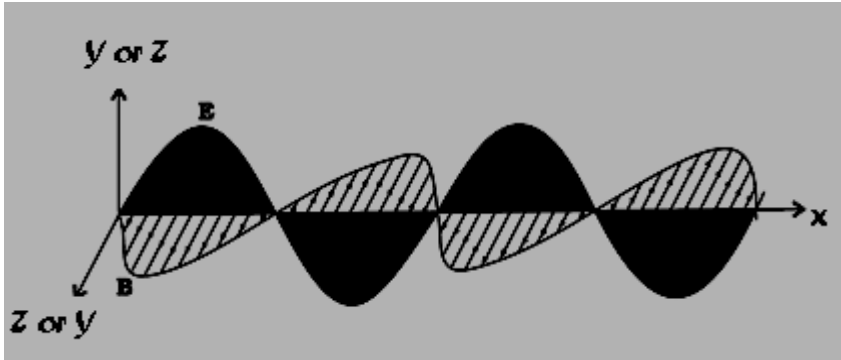
	<p>(a)</p>  <p>[ NOTE: Accept the alternative choices indicating the correct directions of the oscillating components of E and B ]</p> <p>(b) <math>\frac{E_0}{B_0} = c</math></p>	<p>1 ½</p> <p>½</p>	<p>2</p>				
<p>17.</p>	<table border="1" data-bbox="240 877 1170 970"> <tr> <td>(a) Cause of release of energy</td> <td>1</td> </tr> <tr> <td>(b) Proof for independence of nuclear density on mass number</td> <td>2</td> </tr> </table> <p>(a) Since the total initial mass of nuclei on the left side of reaction is greater than the total final mass of nucleus on the right hand side, this difference of mass appears as the energy released.</p> <p style="text-align: center;">As <math>R = R_0 A^{1/3}</math></p>	(a) Cause of release of energy	1	(b) Proof for independence of nuclear density on mass number	2	<p>1</p> <p>½</p> <p>½</p> <p>½</p>	<p>3</p>
(a) Cause of release of energy	1						
(b) Proof for independence of nuclear density on mass number	2						
<p>18.</p>	<table border="1" data-bbox="230 1705 1258 1818"> <tr> <td>(a) Reasons of failure of wave theory to explain Photoelectric effect.</td> <td>1 ½</td> </tr> <tr> <td>(b) Basic features of Photon picture</td> <td>1 ½</td> </tr> </table> <p>(a) According to wave theory</p>	(a) Reasons of failure of wave theory to explain Photoelectric effect.	1 ½	(b) Basic features of Photon picture	1 ½		
(a) Reasons of failure of wave theory to explain Photoelectric effect.	1 ½						
(b) Basic features of Photon picture	1 ½						

	<p>(i) The maximum kinetic energy of the emitted electron should be directly proportional to the intensity of incident radiations but it is not observed experimentally. Also maximum kinetic energy of the emitted electrons should not depend upon incident frequency according to wave theory, but it is not so.</p> <p>(ii) Electron emission should take place at all frequencies of radiations i.e. there should not exist the threshold frequency. This fact contradicts experimental observation.</p> <p>(iii) There should be a time lag in photoelectric emission but according to observation photoelectric emission is instantaneous.</p> <p>(b) According to photon picture</p> <p>(i) Each quantum of radiation has energy <math>h\nu</math></p> <p>(ii) In photoelectric effect the electrons in the metal absorb this quantum of energy <math>h\nu</math></p> <p>(iii) When this energy exceeds the minimum energy needed for the electron</p>	<p><math>\frac{1}{2}</math></p> <p><math>\frac{1}{2}</math></p> <p><math>\frac{1}{2}</math></p> <p><math>\frac{1}{2}</math></p> <p><math>\frac{1}{2}</math></p>	<p>3</p>				
<p>19.</p>	<table border="1" data-bbox="272 1163 1260 1255"> <tr> <td data-bbox="279 1171 1117 1205">Derivation of expression for KE and PE</td> <td data-bbox="1117 1171 1253 1205">1 + 1</td> </tr> <tr> <td data-bbox="279 1205 1117 1239">Energy level diagram for Lyman series</td> <td data-bbox="1117 1205 1253 1239">1</td> </tr> </table> <p>From (i) and (ii)</p>	Derivation of expression for KE and PE	1 + 1	Energy level diagram for Lyman series	1	<p><math>\frac{1}{2}</math></p> <p><math>\frac{1}{2}</math></p>	
Derivation of expression for KE and PE	1 + 1						
Energy level diagram for Lyman series	1						

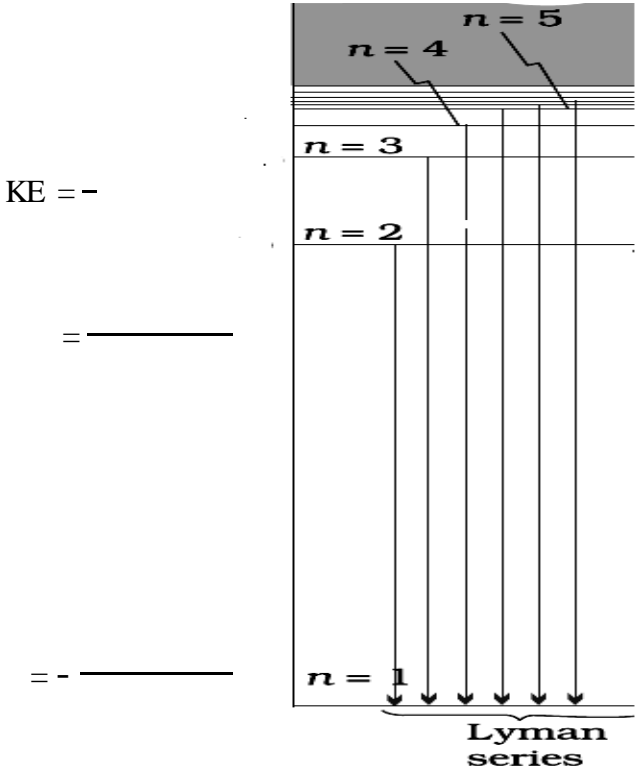
	<p>Kinetic energy</p> <p>Potential energy</p> <p>Energy level diagram for Lyman series</p> 	<p><math>\frac{1}{2}</math></p> <p><math>\frac{1}{2}</math></p> <p>1</p>	<p>3</p>								
<p>20.</p>	<table border="1" data-bbox="256 1671 1284 1843"> <tr> <td>Plot of variation of current with angular frequency</td> <td>1</td> </tr> <tr> <td>Condition for resonance</td> <td><math>\frac{1}{2}</math></td> </tr> <tr> <td>Value of resistance for sharper resonance</td> <td><math>\frac{1}{2}</math></td> </tr> <tr> <td>Definition of Q-factor and its significance</td> <td><math>\frac{1}{2} + \frac{1}{2}</math></td> </tr> </table>	Plot of variation of current with angular frequency	1	Condition for resonance	$\frac{1}{2}$	Value of resistance for sharper resonance	$\frac{1}{2}$	Definition of Q-factor and its significance	$\frac{1}{2} + \frac{1}{2}$		
Plot of variation of current with angular frequency	1										
Condition for resonance	$\frac{1}{2}$										
Value of resistance for sharper resonance	$\frac{1}{2}$										
Definition of Q-factor and its significance	$\frac{1}{2} + \frac{1}{2}$										

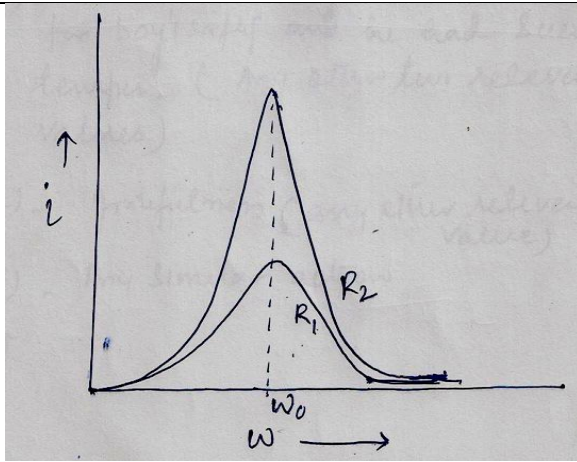

Condition for resonance  $X_L = X_C$

Resonance will be sharper for resistance  $R_2$

Significance of Q factor

For large Q factor, resonance will be sharper and therefore circuit will be more selective

1

1/2

1/2

1/2

1/2

3

21.

(i) Calculation of potential V and unknown capacitance C	2
(ii) Calculation of charge stored Q	1

(i)

$$Q = CV$$

1/2

1/2

1/2

Substituting the value of C  
Potential  $V = 180 \text{ V}$

1/2

(ii) Charge stored when voltage is increased by 120 V

1/2

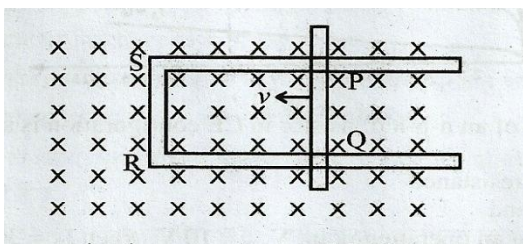

	<p style="text-align: center;"><b>OR</b></p> <table border="1" style="width: 100%; border-collapse: collapse;"> <tr> <td style="width: 80%;">(i) Calculation of net electric flux</td> <td style="width: 20%; text-align: right;">2</td> </tr> <tr> <td>(ii) Calculation of charge</td> <td style="text-align: right;">1</td> </tr> </table> <p>(i) The magnitude of the electric field at the left face is <math>E = 50 \text{ NC}^{-1}</math> Therefore flux through this face</p> <p style="text-align: center;">=</p> <p>The magnitude of the electric field at the right face is <math>E = 100 \text{ NC}^{-1}</math> Therefore flux through this face</p> <p style="margin-left: 40px;"><math>Q = 2</math> <math>= 600</math></p> <p>Therefore net flux through the cylinder is</p> <p>(ii) Charge enclosed by the cylinder</p> <p style="text-align: center;">C</p>	(i) Calculation of net electric flux	2	(ii) Calculation of charge	1	<p><math>\frac{1}{2}</math></p> <p><math>\frac{1}{2}</math></p> <p><math>\frac{1}{2}</math></p> <p><math>\frac{1}{2}</math></p> <p><math>\frac{1}{2}</math></p> <p><math>\frac{1}{2}</math></p> <p><math>\frac{1}{2}</math></p>	<p>3</p> <p>3</p>		
(i) Calculation of net electric flux	2								
(ii) Calculation of charge	1								
22	<table border="1" style="width: 100%; border-collapse: collapse;"> <tr> <td style="width: 80%;">Expression for (i) Current in loop</td> <td style="width: 20%; text-align: right;">1</td> </tr> <tr> <td>(ii) Force</td> <td style="text-align: right;">1</td> </tr> <tr> <td>(iii) Power Required</td> <td style="text-align: right;">1</td> </tr> </table> <div style="text-align: center; margin: 10px 0;">  </div> <p>Let the magnetic field acting on the loop be <math>B</math> and length of the rod <math>PQ</math> be <math>l</math></p>	Expression for (i) Current in loop	1	(ii) Force	1	(iii) Power Required	1		
Expression for (i) Current in loop	1								
(ii) Force	1								
(iii) Power Required	1								

	<p>The induced emf</p> <p>(i) Current in the loop</p> <p>(ii) Force <math>F = i \ell B</math></p>	<p><math>\frac{1}{2}</math></p> <p><math>\frac{1}{2}</math></p> <p><math>\frac{1}{2}</math></p> <p><math>\frac{1}{2}</math></p> <p><math>\frac{1}{2}</math></p>	<p>3</p>								
<p>23.</p>	<table border="1" data-bbox="228 995 1308 1125"> <tr> <td>Distinction between sky waves and space waves modes of propagation</td> <td>1</td> </tr> <tr> <td>(a) Restriction of sky wave propagation</td> <td>1</td> </tr> <tr> <td>(b) Two examples</td> <td><math>\frac{1}{2} + \frac{1}{2}</math></td> </tr> </table> <p>Sky wave communication is achieved by ionospheric reflection of radio waves back towards the earth, while in space wave propagation, the radio waves travel in straight lines from transmitting antenna to the receiving antenna.</p> <p>(a) The radio waves of frequencies more than 40 MHz penetrates into the ionosphere.</p> <p>(b) Television broadcast, Microwave link and satellite communication (any two)</p>	Distinction between sky waves and space waves modes of propagation	1	(a) Restriction of sky wave propagation	1	(b) Two examples	$\frac{1}{2} + \frac{1}{2}$	<p>1</p> <p>1</p> <p><math>\frac{1}{2} + \frac{1}{2}</math></p>	<p>3</p>		
Distinction between sky waves and space waves modes of propagation	1										
(a) Restriction of sky wave propagation	1										
(b) Two examples	$\frac{1}{2} + \frac{1}{2}$										
<p>24.</p>	<table border="1" data-bbox="228 1549 1281 1734"> <tr> <td>Determination of</td> <td></td> </tr> <tr> <td>(i) Dynamic output resistance</td> <td><math>\frac{1}{2} + \frac{1}{2}</math></td> </tr> <tr> <td>(ii) d.c current gain</td> <td><math>\frac{1}{2} + \frac{1}{2}</math></td> </tr> <tr> <td>(iii) a.c current gain</td> <td><math>\frac{1}{2} + \frac{1}{2}</math></td> </tr> </table> <p>(1) Dynamic output resistance</p>	Determination of		(i) Dynamic output resistance	$\frac{1}{2} + \frac{1}{2}$	(ii) d.c current gain	$\frac{1}{2} + \frac{1}{2}$	(iii) a.c current gain	$\frac{1}{2} + \frac{1}{2}$	<p><math>\frac{1}{2}</math></p>	
Determination of											
(i) Dynamic output resistance	$\frac{1}{2} + \frac{1}{2}$										
(ii) d.c current gain	$\frac{1}{2} + \frac{1}{2}$										
(iii) a.c current gain	$\frac{1}{2} + \frac{1}{2}$										

	$r_0 = \left( \frac{\Delta V_{CE}}{\Delta I_C} \right) I_b$ $= 0.2 \text{ mA}$ $r_0 = \text{—————} = 20 \text{ K } \Omega$ <p>(2) dc current gain, at 10 V, <math>I_C = 3.6 \text{ mA}</math></p> $\beta = \frac{I_c}{I_b} = \frac{3.6 \times 10^{-3}}{30 \times 10^{-6}} = 120$ <p>(3) ac current gain</p> $\Delta I_b = 40 \mu\text{A} - 30 \mu\text{A} = 10 \mu\text{A}$ $\Delta I_c = 47 \text{ mA} - 3.6 \text{ mA} = 1.1 \text{ mA}$ $\beta_{ac} = \left( \frac{\Delta I_c}{\Delta I_b} \right)$ <p>From the graph <math>= \frac{1.1 \times 10^{-3} (12 - 8)}{10 \times 10^{-6} (37 - 35)} = 4 \text{ V}</math></p> <p>[NOTE: Credit should also be given to candidate who uses the right procedure, but considers the values slightly different from those used above]</p>	<p><math>\frac{1}{2}</math></p> <p><math>\frac{1}{2} + \frac{1}{2}</math></p> <p><math>\frac{1}{2}</math></p> <p><math>\frac{1}{2}</math></p>	<p>3</p>
<p>25.</p>	<div style="border: 1px solid black; padding: 5px; margin-bottom: 10px;"> <p>(a) Relationship between interference pattern and diffraction from each slit 1  (b) Calculation of separation between the position of first maxima of two wavelengths 2</p> </div> <p>a) In double slit experiment, the pattern on the screen is actually a superposition of single slit diffraction from each slit and double slit interference pattern. As a result, there appears a broader diffraction peak in which there occur several fringes of smaller widths due to double slit interference. 1</p> <p>b) Distance of first secondary maximum from centre of the screen</p> $x = \frac{3 D \lambda}{2 a}$ <p>Therefore spacing between first secondary maxima on the screen for two given wavelengths <math>\frac{1}{2}</math></p>	<p><math>\frac{1}{2}</math></p> <p><math>\frac{1}{2}</math></p>	

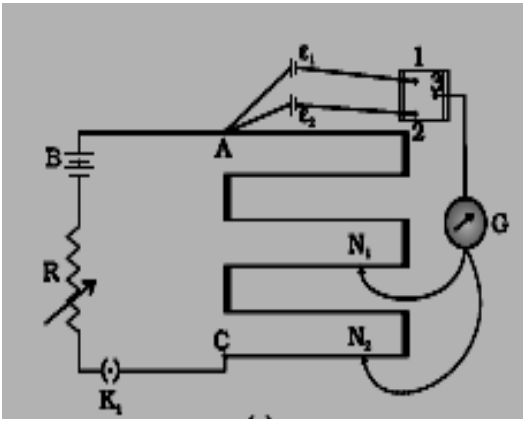
	$\Delta x = \frac{3D}{2a} (\lambda_2 - \lambda_1)$ $= \frac{3 \times 1.5}{2 \times 2 \times 10^{-4}} (96 - 590) \times 10^{-9}$ $= \frac{4.5 \times 6 \times 10^{-5}}{4}$ $= 6.75 \times 10^{-5} \text{ m}$	1/2									
26.	<div style="border: 1px solid black; padding: 5px; text-align: center;"> <p>Four parts <span style="margin-left: 200px;">1 mark for each part</span></p> </div> <p>a) Because during thunder storm car would act as an electrostatic shield</p> <p>b) Dr. Pat hak displayed values of safety of human life, helpfulness, empathy and scientific temper. ( or any other two relevant values)</p> <p>c) Gr atefulness, indebtedness ( or any other relevant value)</p> <p>d) Exa mple of any si milar acti on</p>	<p>1</p> <p>1/2 + 1/2</p> <p>1</p> <p>1</p>	3								
27.	<div style="border: 1px solid black; padding: 5px;"> <table style="width: 100%; border-collapse: collapse;"> <tr> <td style="padding: 2px 5px;">(a) Working principle of potentiometer</td> <td style="text-align: right; padding: 2px 5px;">1</td> </tr> <tr> <td style="padding: 2px 5px;">Diagram</td> <td style="text-align: right; padding: 2px 5px;">1</td> </tr> <tr> <td style="padding: 2px 5px;">Expression</td> <td style="text-align: right; padding: 2px 5px;">1</td> </tr> <tr> <td style="padding: 2px 5px;">(b) Two possible causes for one sided deflection</td> <td style="text-align: right; padding: 2px 5px;">1+1</td> </tr> </table> <p>(a) Principle : When a constant current flows through a wire of uniform area of cross section then potential difference between two points on the wire is directly proportional to length of this section of wire.</p> <p style="text-align: center;"><math>V \propto l</math></p>  </div>	(a) Working principle of potentiometer	1	Diagram	1	Expression	1	(b) Two possible causes for one sided deflection	1+1	1	4
(a) Working principle of potentiometer	1										
Diagram	1										
Expression	1										
(b) Two possible causes for one sided deflection	1+1										

$$\Rightarrow \frac{\epsilon_1}{\epsilon_2} = \frac{l_1}{l_2}$$

- (b) (i) When the driver cell/ source cell has emf less than the emf of the cells to be compared  
(ii) When the positive end of the potentiometer wire is connected to negative terminal of the cell whose emf is to be compared/ determined

OR

(a) Statement of Kirchhoff's rule	1/2 + 1/2
Obtaining the balance condition in Wheatstone Bridge	2
(b) Calculation of values of R <sub>1</sub> and R <sub>2</sub>	2

(a)(i) Algebraic sum of the currents entering the junction is equal to the sum of currents leaving the junction  
 $\epsilon_2 = \epsilon_1$

(ii) The Algebraic sum of the changes in potential around any closed loop involving resistors and cells is zero.

[Alternatively accept the mathematical form of the Kirchhoff's rule]

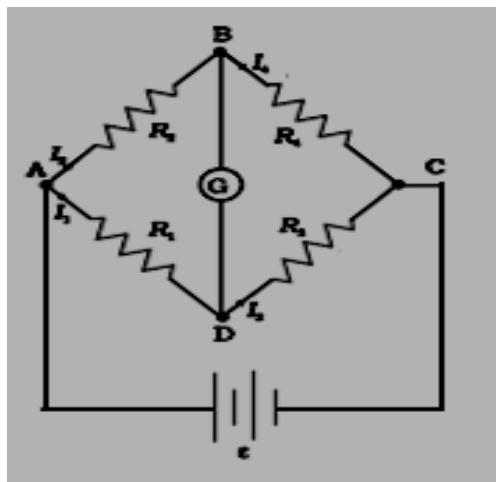

In loop ADBA  
 $-I_1 R_1 + 0 + I_2 R_2 = 0$   
 $\Rightarrow I_1 R_1 = I_2 R_2$

In loop CBDC  
 $I_2 R_4 + 0 - I_1 R_3 = 0$

	$\Rightarrow I_2 R_4 = I_1 R_3$ $\Rightarrow \frac{R_1}{R_2} = \frac{R_3}{R_4}$ <p>(b) <math>\frac{R_1}{R_2} = \frac{40}{60} = \frac{2}{3}</math></p> $\frac{R_1 + 10}{R_2} = \frac{60}{40} = \frac{3}{2}$ $\frac{R_1}{R_2} + \frac{10}{R_2} = \frac{3}{2}$ $\Rightarrow \frac{2}{3} + \frac{10}{R_2} = \frac{3}{2}$ $\Rightarrow R_2 = 12 \Omega$ <p>Substituting for <math>R_2</math> and finding the value of <math>R_1</math>  <math>R_1 = 8 \Omega</math></p>	<p><math>\frac{1}{2}</math></p> <p><math>\frac{1}{2}</math></p> <p><math>\frac{1}{2}</math></p> <p><math>\frac{1}{2}</math></p> <p><math>\frac{1}{2}</math></p> <p><math>\frac{1}{2}</math></p>	<p>5</p>
--	--	---	----------

28.

- |  |   |
|--|---|
| (a) Derivation of the expression for the torque with diagram | 3 |
| (b) Depiction of the trajectories                            | 2 |

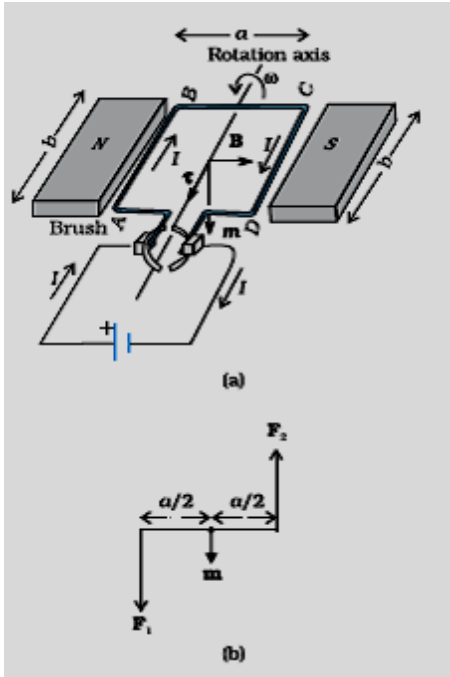

(a)

1

The magnetic field exerts no force on the two arms AD and BC of the loop.  
Force  $F_1$  acts on arm AB directing into the plane.

$$F_1 = I b B$$

Force  $F_2$  acts on arm CD directing out of the plane.

$$F_2 = I b B = F_1$$

Hence there is a torque on the loop due to forces  $F_1$  and  $F_2$

$$\frac{a}{2} \quad \frac{a}{2}$$

$$= I b B \frac{a}{2} + I b B \frac{a}{2} = I (ab) B = I A B \text{ where } A = ab \text{ is the area of the loop}$$

(b)

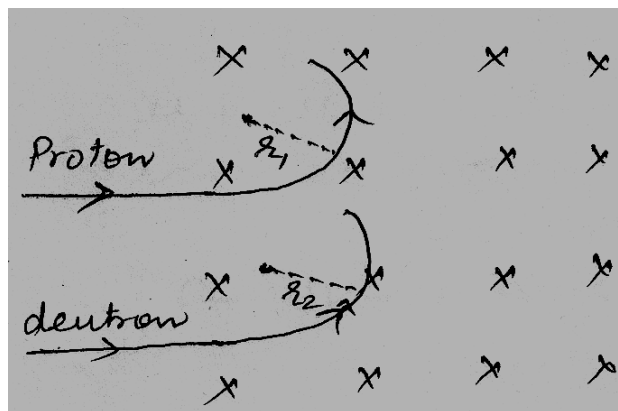

Here  $r_1 = r_2$

(Since the momenta of charged particles are equal and they have equal charge, therefore they will describe circular trajectories of same radius)

[If the candidate only mentions that they describe circular trajectories without the diagram, one mark should be awarded]

OR

- |  |     |
|--|-----|
| (a) Execution of SHM of compass needle in magnetic field                         | 2   |
| Derivation of its time period  | 1   |
| (b) Finding (i) horizontal component of earth's magnetic field (ii) angle of dip | 1+1 |

(a) Torque acting on the compass needle suspended freely in a uniform magnetic field

It will be balanced by the restoring torque

1/2

1/2

1/2

1/2

1

1

5

1/2

	<p>For small angle <math>\sin\theta \approx \theta</math></p> <p>In equilibrium the resulting equation of motion</p> <p>[If the student just writes that the needle,</p> <p>(i) When slightly disturbed from its stable position experiences a torque due to the magnetic field and</p> <p>(ii) writes the expression for this torque , Award (1 + 1 =2) marks ]</p> $\Rightarrow \frac{d^2\theta}{dt^2} = - \left( \frac{MB}{I} \right)$ <p>(b) (i) Horizontal component of Earth's magnetic field =0 as <math>\frac{d^2\theta}{dt^2}</math> Hence its motion is simple harmonic (ii) The value of angle of dip at that place =90° <math>\Rightarrow \tan^2 \delta = \frac{MB}{I}</math></p>	<p>1/2</p> <p>1/2</p> <p>1/2</p> <p>1/2</p> <p>1/2</p> <p>1</p> <p>1</p>	<p>5</p>								
29.	<table border="1" style="width: 100%;"> <tr> <td>(a) Ray diagram showing image formation</td> <td style="text-align: right;">1</td> </tr> <tr> <td>Derivation of expression for magnification</td> <td style="text-align: right;">2</td> </tr> <tr> <td>(b) Distinction between myopia and hypermetropia</td> <td style="text-align: right;">1</td> </tr> <tr> <td>Correction of defects by diagram</td> <td style="text-align: right;">1</td> </tr> </table>	(a) Ray diagram showing image formation	1	Derivation of expression for magnification	2	(b) Distinction between myopia and hypermetropia	1	Correction of defects by diagram	1		
(a) Ray diagram showing image formation	1										
Derivation of expression for magnification	2										
(b) Distinction between myopia and hypermetropia	1										
Correction of defects by diagram	1										



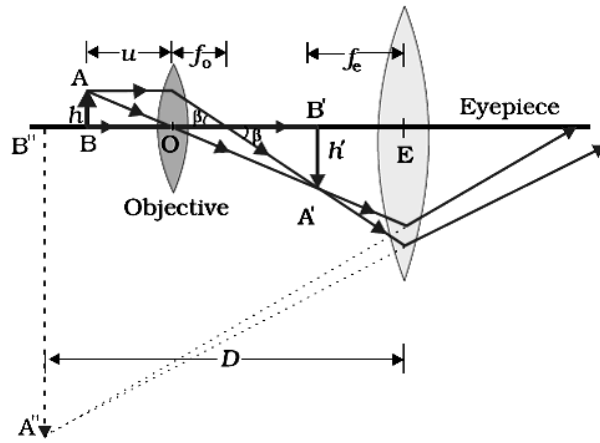

Magnification of objective

$$m_0 = \frac{h'}{h} = \frac{L}{f_0}$$

Angular magnification due to eyepiece

Total magnification when image is formed at infinity

$$m = m_0 \cdot m_e$$

(b)

Myopia	Hypermetropia
1. Distant object arriving at the eye lens get converged at a point in front of the retina	1. Eyelens focuses the incoming light behind retina
2. The eye ball is elongated	2. The eye ball is shortened
3. Person cannot see distant objects clearly.	3. Person cannot see nearby objects clearly.

(Any two or any other correct answer)

$$m = \frac{h'}{h}$$

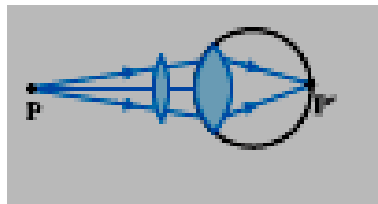
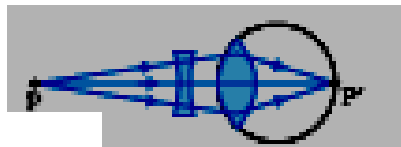

=

1

1/2

1/2

1/2

1/2

1/2 + 1/2

1/2 + 1/2

Myopia can be corrected by interposing a concave lens between eye and object

Hypermetropia can be corrected by interposing a convex lens between eye and object

[Award only half mark if diagrams not drawn, award full mark even if explanation is not written]

OR

(a) Statement of Huygen's principle	1
Diagram	1
Verification of Snell's law	1
(b) Explanation of (i) and (ii)	1+1

(a) According to Huygens principle, each point of the wavefront is the source of a secondary disturbance and the wavelets emanating from these points spread out in all directions with the speed of the wave. A common tangent to all these wavelets, gives the new position of the wavefront at a later time.

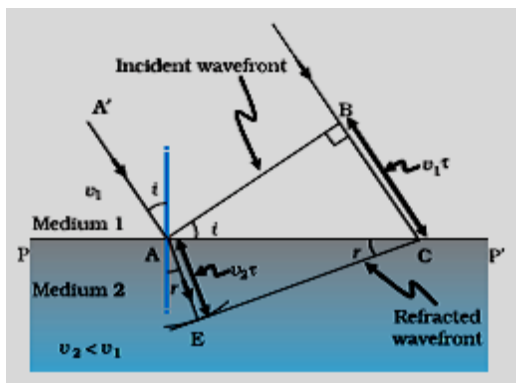

Verification of Snell's law

From figure

$$\sin i = \frac{BC}{AC} = \frac{v_1 t}{AC}$$

$$\sin r = \frac{AE}{AC} = \frac{v_2 t}{AC}$$

$$\frac{\sin i}{\sin r} = \frac{v_1}{v_2} = \mu$$

(b) Yes,

(i) Reflection and refraction arise through interaction of incident light with the atomic constituents of matter. Atoms may be viewed as oscillators, which take up the frequency of the external agency (light) causing forced oscillations. The frequency of light emitted by a charged oscillator equals its frequency of

5

1

1

1/2

1/2

	oscillation. Thus, the frequency of scattered light equals the frequency of incident light. [Any other correct explanation]	1	
	(ii) No. Energy carried by a wave depends on the amplitude of the wave, not on the speed of wave propagation.	1	5